

END VIEW

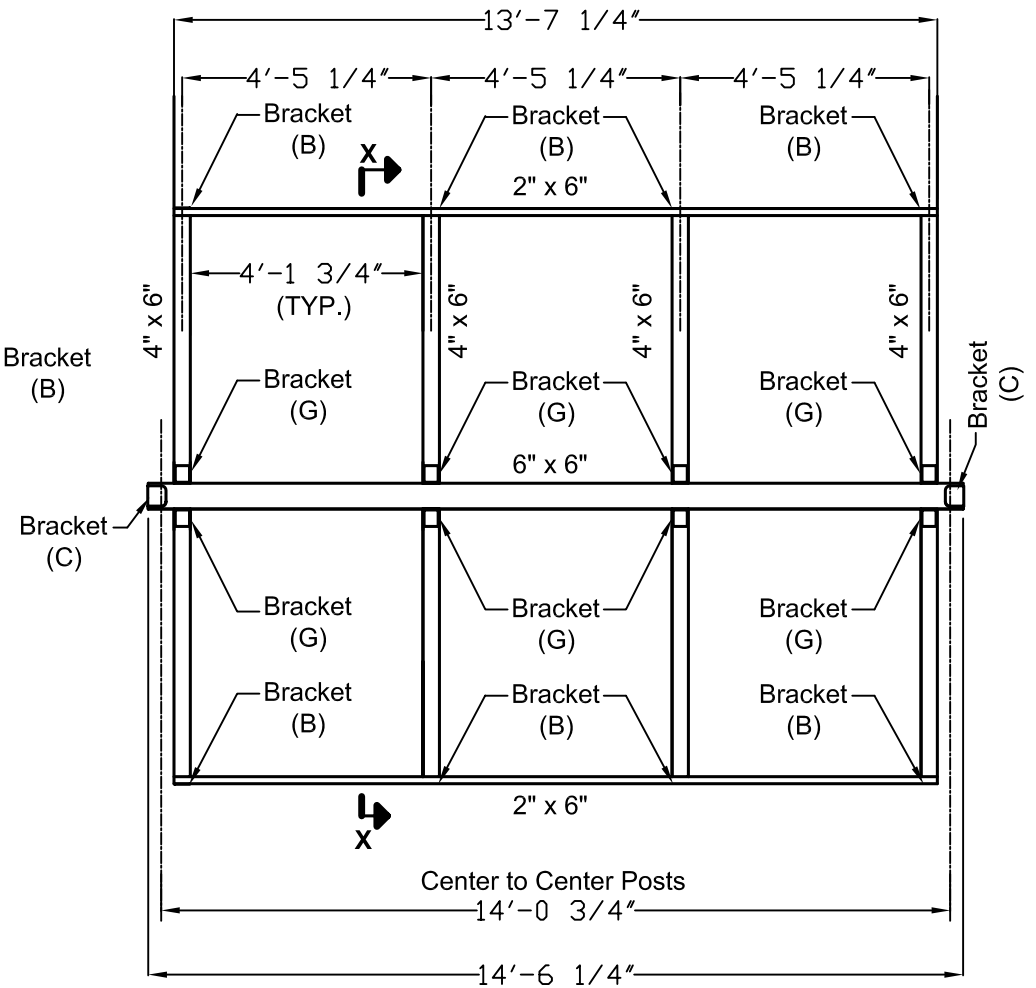

PLAN AT TRACK BEAMS

SHADETREE[®]
Retractable Patio & Deck Canopies

6317 Busch Blvd • Columbus, Ohio 43229
Phone: 614-844-5990 • Fax: 614-844-5991
Corporate e-mail: info@shadetreecanopies.com • Design Hotline: 1-888-307-4233

FILE:

DATE:

SCALE: NOT TO SCALE

DRAWN BY: JOHN MOLNAR

Flat Cantilever Strip Track Canopy System

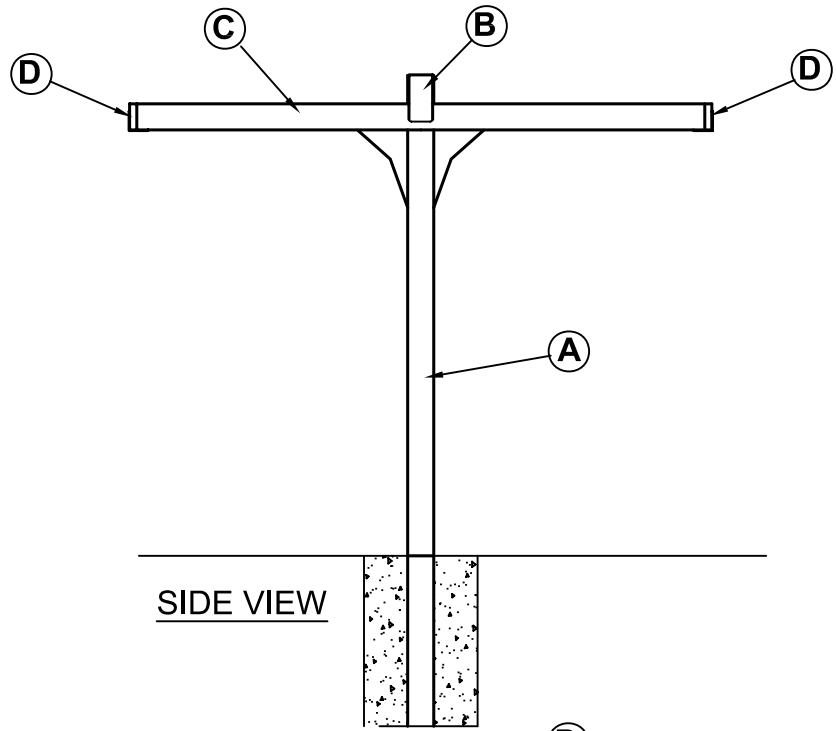

SIDE VIEW

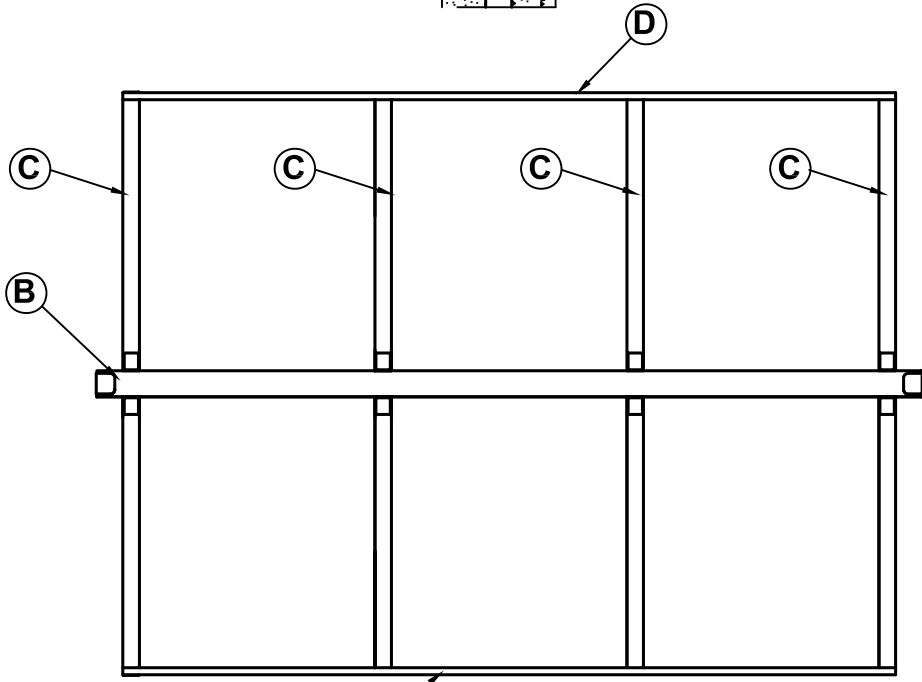

TOP VIEW

Flat Cantilever Strip Track System

Quantity

2	(A)	6" x 6" x 10'-11 1/2" Post	☒	
	(A)	6" x 6" x 10'-11 1/2" Post	☒	
1	(B)	6" x 6" x 14'-6 1/4" Ridge Beam	☒	
2	(C)	4" x 6" x 10' Beam	☒	
	(C)	4" x 6" x 10' Beam	☒	
	(C)	4" x 6" x 10' Beam	☒	
	(C)	4" x 6" x 10' Beam	☒	
2	(D)	2" x 6" x 13'-7 1/4" Header	☒	
	(D)	2" x 6" x 13'-7 1/4" Header	☒	

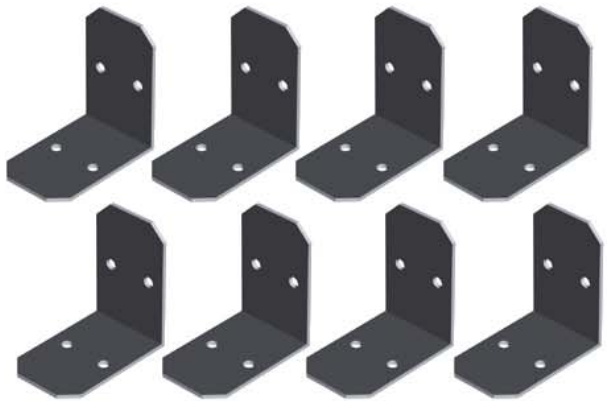

Bracket B (8)

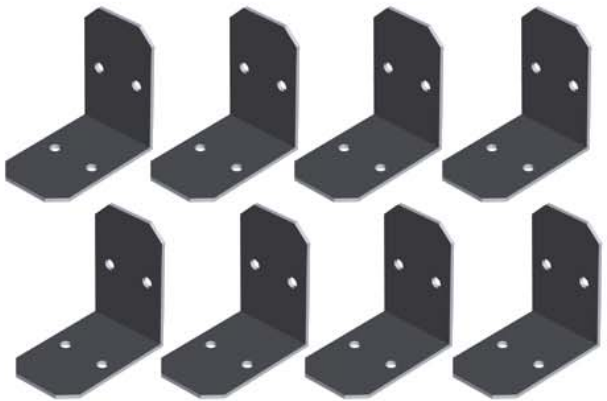

Bracket G (8)

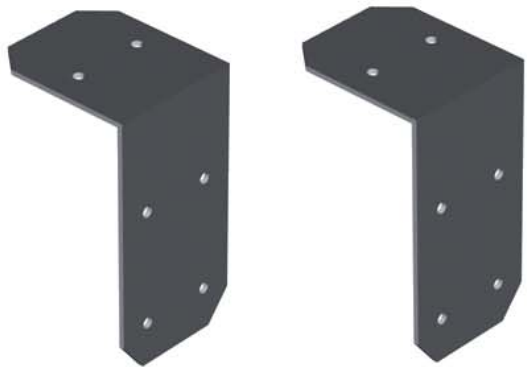

Bracket C (2)

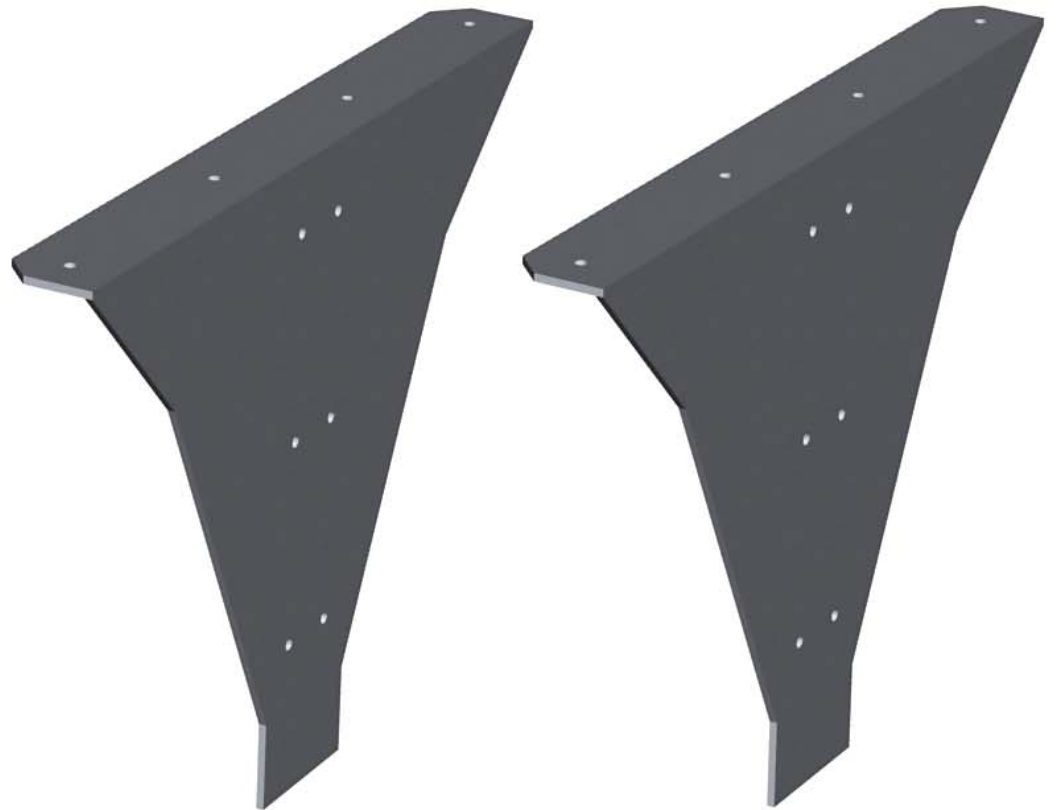

Bracket F (2)

Flat Cantilever Strip Track
Canopy System Bracket List

Wood Materials List
to present to lumber company

2 - 6" x 6" x 12'

1 - 6" x 6" x 16'

4 - 4" x 6" x 12'

2 - 2" x 6" x 16'



SHADETREE °
Retractable Patio & Deck Canopies

6317 Busch Blvd • Columbus, Ohio 43229
Phone: 614-844-9990 • Fax: 614-844-9991
Corporate e-mail: info@shadetreecanopies.com • Design Hotline: 1-888-307-4233

FILE:

DATE:

SCALE: NOT TO SCALE

DRAWN BY: JOHN MOLNAR

**Flat Cantilever Strip Track
Canopy System**