

**SHADE TREE** °

Retractable Patio & Deck Canopies

6317 Busch Blvd • Columbus, Ohio 43229

Phone: 614-844-5990 • Fax: 614-844-5991

Corporate e-mail: info@shadetreecanopies.com • Design Hotline: 1-888-307-4233

FILE:

DATE:

SCALE: NOT TO SCALE

DRAWN BY: JOHN MOLNAR

## Single Cantilever Strip Track Canopy System

## Single Cantilever Strip Track System

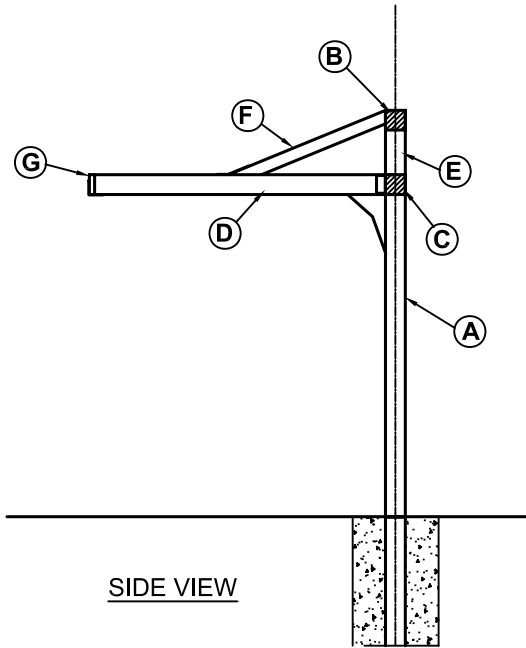



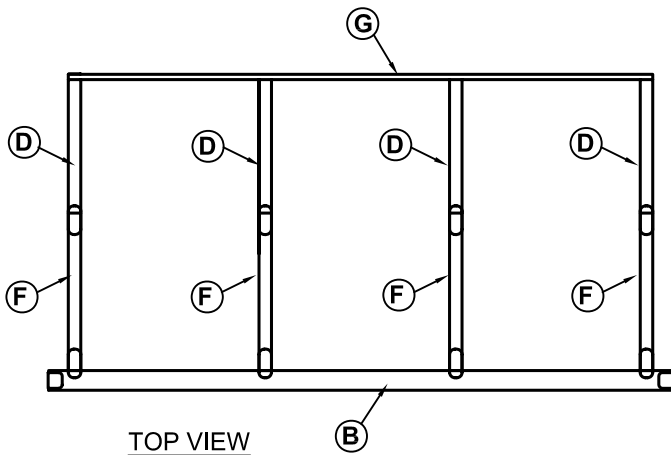





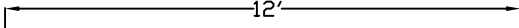

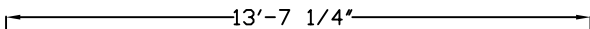
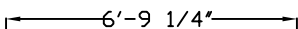

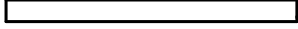
SIDE VIEW

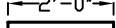

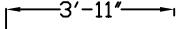
TOP VIEW

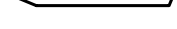
### Quantity

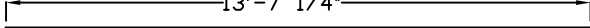
2	(A)	6" x 6" x 12'-0" Post	☒	
	(A)	6" x 6" x 12'-0" Post	☒	
1	(B)	6" x 6" x 14'-6 1/4" Ridge Beam	☒	
1	(C)	6" x 6" x 13'-7 1/4" Header	☒	
4	(D)	4" x 6" x 6'-9 1/4" Beam	☒	
	(D)	4" x 6" x 6'-9 1/4" Beam	☒	
	(D)	4" x 6" x 6'-9 1/4" Beam	☒	
	(D)	4" x 6" x 6'-9 1/4" Beam	☒	
2	(E)	4" x 6" x 2' Beam	☒	
	(E)	4" x 6" x 2' Beam	☒	
4	(F)	4" x 4" x 3'-11" Support	☒	
	(F)	4" x 4" x 3'-11" Support	☒	
	(F)	4" x 4" x 3'-11" Support	☒	
	(F)	4" x 4" x 3'-11" Support	☒	
1	(G)	2" x 6" x 13'-7 1/4" Header	☒	

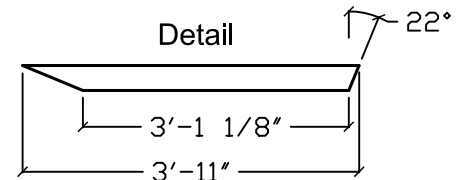

Detail

22°



Bracket A (8)

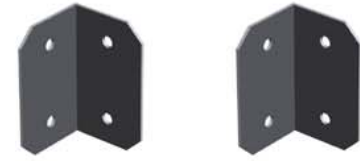

Bracket E (2)

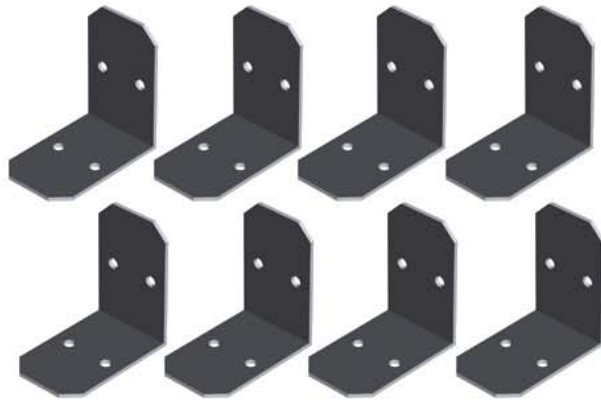

Bracket B (8)

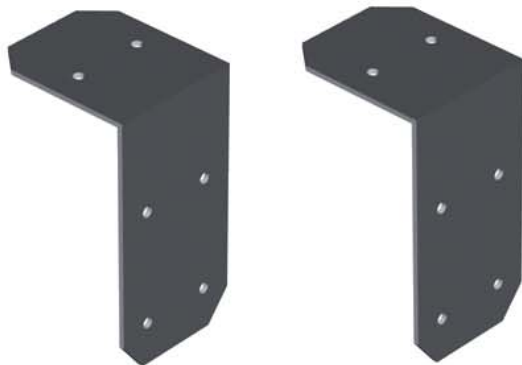

Bracket C (2)



Bracket D (2)

Single Cantilever Strip Track  
Canopy System Bracket List

## Wood Materials List to present to lumber company

2 - 6" x 6" x 12'

2 - 6" x 6" x 16'

5 - 4" x 6" x 8'

4 - 4" x 4" x 8'

1 - 2" x 6" x 16'



**SHADE TREE** °

Retractable Patio & Deck Canopies

6317 Busch Blvd • Columbus, Ohio 43229  
Phone: 614-844-5990 • Fax: 614-844-5991  
Corporate e-mail: [info@shadetreecanopies.com](mailto:info@shadetreecanopies.com) • Design Hotline: 1-888-307-4233

FILE:

DATE:

SCALE: NOT TO SCALE

DRAWN BY: JOHN MOLNAR

### Single Cantilever Strip Track Canopy System